

Kit Includes

- One (1) or Two (2) 3" LED Pods
- Deutsch-style wire pigtail
- Mounting bracket and hardware

Features

- Advanced TIR (total internal reflection) optics
- High intensity LED chips
- Durable powdercoated aluminum construction
- Integrated Deutsch-style connector
- Pin fin heatsink design

Wiring

Connect the red wire to positive supply, and black wire to negative or common ground. Tap the blue wire for the backlight to a 12V switched source, or to your desired vehicle function. If you have a fourth wire, it will not be used.

NOTE: This auxiliary lamp draws high current, and requires adequately-sized wiring for safe operation. If you are not using a Diode Dynamics wiring harness, using wire sized 16 AWG or larger. Be mindful of current requirements, especially if you are wiring multiple pods on a single circuit. **All power sources must be properly fused and capable of safely delivering the required current.** If you are unsure, contact us for assistance, or a professional electrical installer.

Mounting

If you wish, you may use the included hardware to mount your pod. Fasteners are included. The most common mounting style is shown below. Stage Series Pods are also compatible with most standard mounting brackets on the market.

Specifications

- **Input Voltage:** 9-16V SS3 Standard, 9-24V SS3 Backlit
- **Input Power:** SS3 Sport: 14.5 watts (Main Beam)
SS3 Sport: 0.4 watts (Backlight)
SS3 Pro: 36 watts (Main Beam)
SS3 Pro: 0.4 watts (Backlight)
SS3 Max: 38.5 watts (Main Beam)
SS3 Max: 0.4 watts (Backlight)
- **Current Draw:** SS3 Sport: 1.1 amps @ 12.8V (Main Beam)
SS3 Sport: 30 mA @ 12.8V (Backlight)
SS3 Pro: 2.7 amps @ 12.8V (Main Beam)
SS3 Pro: 30 mA @ 12.8V (Backlight)
SS3 Max: 3 amps @ 12.8V (Main Beam)
SS3 Max: 30 mA @ 12.8V (Backlight)
- **Operating Temperature:** -40° to 185°F
- **Weight:** 2.5 lbs (single), 3.5 lbs (pair)

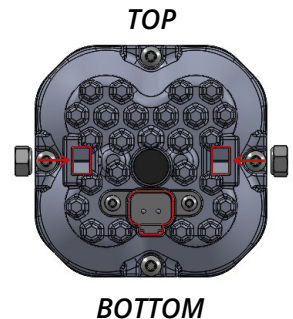
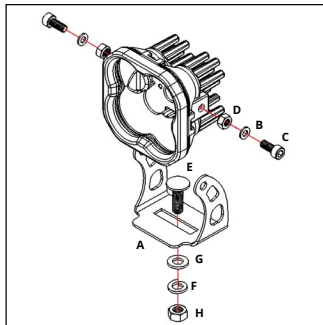
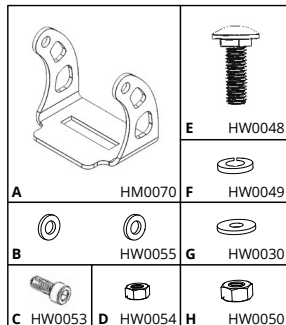

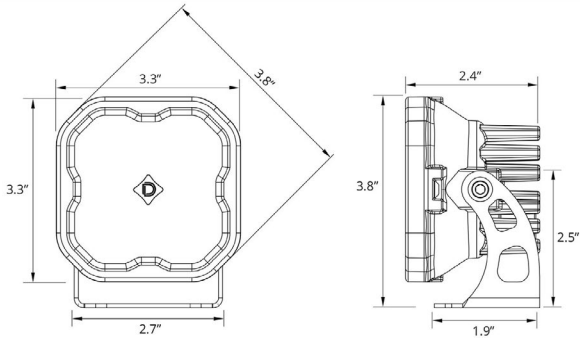

Output

Fog/Wide 

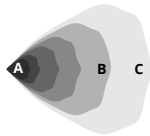

Flood



Combo

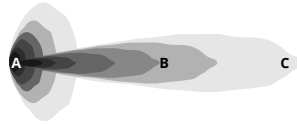

Spot



Driving 

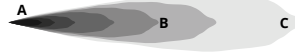

A - lux at 10 meters
 B - Distance (m) with 1 lux
 C - Distance (m) with .25 lux

SS3 SPORT						SS3 PRO				
Lens Color/Optics	cd*	A			SKU	cd*	A			SKU
		Illuminance (lx)	Distance (m)				Illuminance (lx)	Distance (m)		
White Driving	54,700	547	234	470	DD6120	66,500	665	258	520	DD6128
White Flood	1,750	18	42	80	DD6121	3,100	31	56	110	DD6129
White Fog	10,600	106	103	210	DD6122	11,900	119	109	220	DD6130
White Spot	151,000	1510	389	780	DD6123	131,500	1315	363	730	DD6131
White Combo	31,500	315	177	350	DD6479	35,100	351	187	370	DD6481
Yellow Driving	53,500	535	231	460	DD6124	60,900	609	247	490	DD6132
Yellow Flood	1,600	16	40	80	DD6125	2,850	29	53	110	DD6133
Yellow Fog	9,050	91	95	190	DD6126	10,900	109	104	210	DD6134
Yellow Spot	149,000	1490	386	770	DD6127	118,500	1185	344	690	DD6135
Yellow Combo	28,100	281	168	340	DD6480	33,406	334	183	370	DD6482
* PEAK BEAM INTENSITY Measured Output Output Color White 1,520 lumens White 6000K White Yellow 1,300 lumens Yellow 3000K Yellow						* PEAK BEAM INTENSITY Measured Output Output Color White 3,000 lumens White 6000K White Yellow 2,700 lumens Yellow 3000K Yellow				

SS3 Max data available at www.diodedynamics.com