

ROUGH COUNTRY

SUSPENSION SYSTEMS®



1523BAG3

04-08 Ford F150 2wd 4 - 6" Kit

THANK YOU FOR CHOOSING ROUGH COUNTRY FOR YOUR SUSPENSION NEEDS.

Rough Country recommends a certified technician install this system. In addition to these instructions, professional knowledge of disassemble/reassembly procedures as well as post installation checks must be known. Attempts to install this system without this knowledge and expertise may jeopardize the integrity and/or operating safety of the vehicle.

Please read instructions before beginning installation. Check the kit hardware against the parts list on the next 2 pages. Be sure you have all needed parts and know where they go. Also please review tools needed list and make sure you have needed tools.

PRODUCT USE INFORMATION

⚠ WARNING As a general rule, the taller a vehicle is, the easier it will roll. We strongly recommend, because of rollover possibility that seat belts and shoulder harnesses should be worn at all times. Avoid situations where a side rollover may occur.

Generally, braking performance and capability are decreased when larger/heavier tires and wheels are used. Take this into consideration while driving. Do not add, alter, or fabricate any factory or after-market parts to increase vehicle height over the intended height of the Rough Country product purchased. Mixing component brands is not recommended.

Rough Country makes no claims regarding lifting devices and excludes any and all implied claims. We will not be responsible for any product that is altered. If questions exist we will be happy to answer them concerning the design, function, and correct use of our products.

The 4 suspension system was developed using a 33X12.50/18 tire with 18 x 9 wheel with 4 1/2 backspace. When using a stock wheel the maximum tire width is 11 1/2". The lifts were designed to lift the front to level the vehicle. Due to manufacturing, dimension variances, and inflation all tire and wheel combinations should be tested prior to installation on all oversized / wider than stock tires. We recommend a wheel not exceeding 8" in width be used with a minimum backspacing of 4.5" to a maximum of 5".

The 6 suspension system was developed using a 35X12.50/18 tire with 18 x 9 wheel with 4 1/2 backspace. When using a stock wheel the maximum tire width is 11 1/2". The lifts were designed to lift the front to level the vehicle. Due to manufacturing, dimension variances, and inflation all tire and wheel combinations should be tested prior to installation on all oversized / wider than stock tires. We recommend a wheel not exceeding 8" in width be used with a minimum backspacing of 4.5" to a maximum of 5".

⚠ NOTICE NOTICE TO DEALER AND VEHICLE OWNER

Any vehicle equipped with any Rough Country product should have a "Warning to Driver" decal installed on the inside of the windshield or on the vehicle's dash. The decal should act as a constant reminder for whoever is operating the vehicle of its unique handling characteristics.

Tools Needed:

5mm wrench /socket	Floor Jack
8mm wrench /socket	Jack stands
10mm wrench /socket	Hammer
11mm wrench /socket	7/16" wrench /socket
12mm 12 point wrench	9/16 wrench /socket
14mm wrench /socket	5/8" wrench /socket
15mm wrench /socket	3/4" wrench /socket
16mm wrench /socket	1 1/16 socket
18mm wrench /socket	Reciprocating Saw
19mm wrench /socket	Strut Compressor
21mm wrench /socket	(Strut Kits Only)
22mm wrench /socket	
24mm wrench /socket	
30mm wrench /socket	

Torque Specs:

Size	Grade 5	Grade 8	Class 8.8	Class 10.9
5/16"	15 ft/lbs	20 ft/lbs	6MM	5 ft/lbs
3/8"	30 ft/lbs	35 ft/lbs	8MM	18ft/lbs
7/16"	45 ft/lbs	60 ft/lbs	10MM	32ft/lbs
1/2"	65 ft/lbs	90 ft/lbs	12MM	55ft/lbs
9/16"	95 ft/lbs	130 ft/lbs	14MM	85ft/lbs
5/8"	135 ft/lbs	175 ft/lbs	16MM	130ft/lbs
3/4"	185 ft/lbs	280 ft/lbs	18MM	170ft/lbs
				240ft/lbs



Ford F150 2wd 52330/52430 Kit Contents

1523BOX1

PART #	DESCRIPTION	QTY
94003789	FRONT CROSSMEMBER	1
94003790	REAR CROSSMEMBER	1

6"-1524BOX1 / 4"-1523BOX4

PART #	DESCRIPTION	QTY
94003717	RR E-BRAKE BRACKET	1
94003715	RR BRAKE BRACKET	1
94003705	SWAY BAR DROP BRCKT	2
1500	CAM BOLTS	1
1523BAG2	KIT BAG	1
90905500/3500	U-BOLTS	4
94003791/9200A	REAR BLOCKS	2
9/16BAG	U-BOLT BAG	1
94003030C/3781B	STRUT SPACERS	2
84164W	STICKER	1
660771	REAR SHOCKS	2
10MMSTUDBAG-1	STRUT SPACER STUDS	1
89711	BRAKE LINES	1
1523BAG3	INSTRUCTIONS	1
1263BAG2	BLOCK BAG (6" KIT ONLY)	1

1523BOX2

PART #	DESCRIPTION	QTY
94005518	DRIVER SPINDLE	1

1523BOX3

PART #	DESCRIPTION	QTY
94005519	PASS SPINDLE	1

1523BAG2

<i>For Sway Bar Brackets:</i>	
3/8" NYLOCK NUT	4
3/8" X 1" BOLT	4
3/8" WASHERS	8

<i>For E-Brake Bracket:</i>	
5/16" X 1" BOLT	1
5/16" WASHER	2
5/16" NYLOCK NUT	1

<i>For the Rear Brake Line Bracket:</i>	
5/16" X 3/4" BOLT	1
5/16" NYLOCK NUT	1
5/16" WASHER	2

1263BAG2

<i>For the rear blocks:</i>	
7/16" x 3" x 3" U-BOLTS	4
7/16" NUTS	8
7/16" WASHERS	8

10MMSTUDBAG-1

<i>For Strut Spacers:</i>	
10MM STUDS	6
10MM NUT	7
10MM LOCK WASHER	6
10MM FLAT WASHER	6
1/2" JAM NUT	1



52330 4" KIT CONTENTS



52430 6" KIT CONTENTS

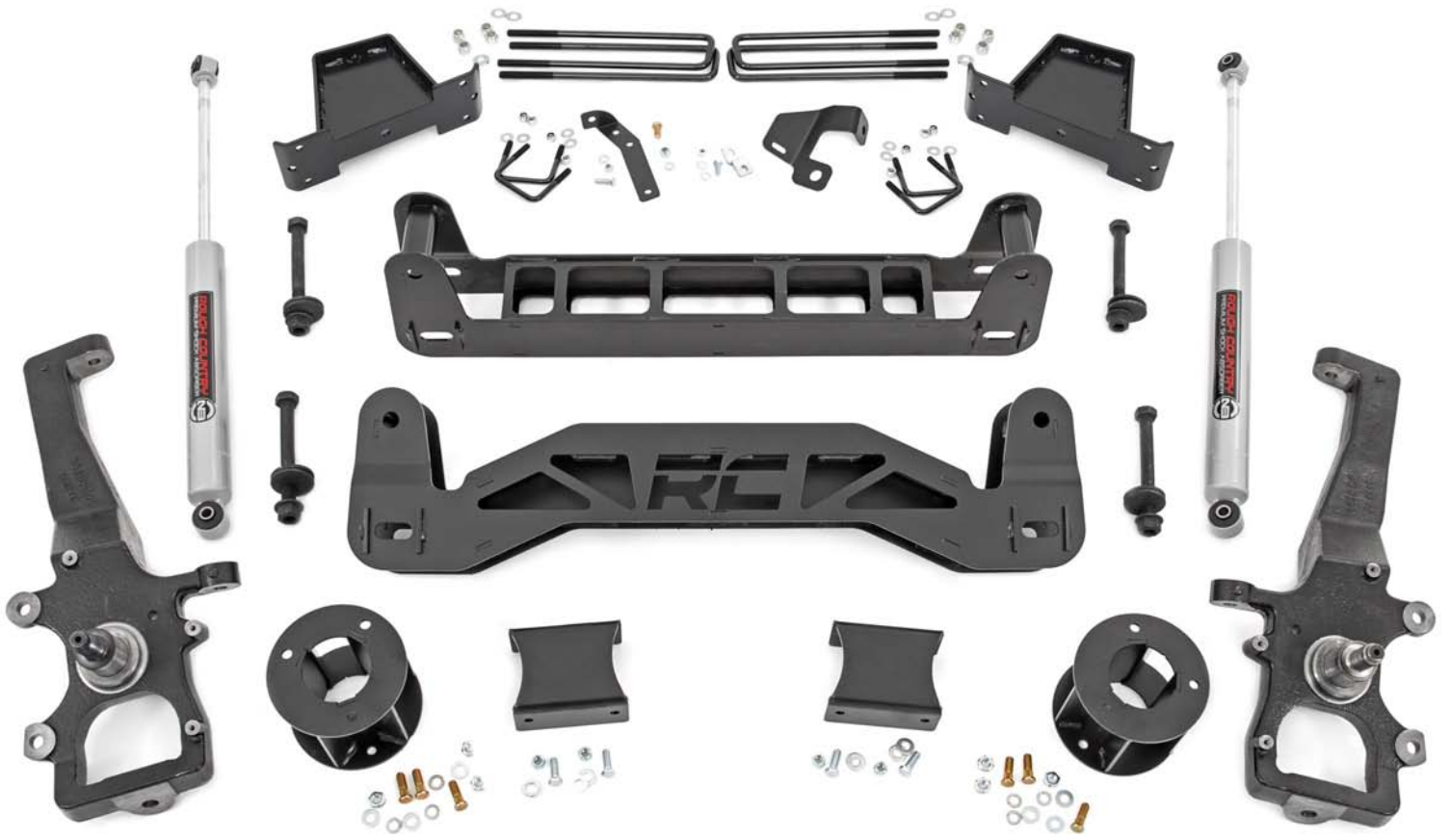

52431 STRUT KIT CONTENTS

1523BOX1

PART #	DESCRIPTION	QTY
94003789	FRONT CROSSMEMBER	1
94003790	REAR CROSSMEMBER	1

1524BOX2

PART #	DESCRIPTION	QTY
94003717	RR E-BRAKE BRACKET	1
94003715	RR BRAKE BRACKET	1
94003705	SWAY BAR DROP BRCKT	2
1500	CAM BOLTS	1
1523BAG2	KIT BAG	1
90905500/3500	U-BOLTS	4
94003791/9200A	REAR BLOCKS	2
9/16BAG	U-BOLT BAG	1
84164W	STICKER	1
660771	REAR SHOCKS	2
89711	BRAKE LINES	1
1523BAG3	INSTRUCTIONS	1
1263BAG2	BLOCK BAG (6" KIT ONLY)	1

1523BOX2

PART #	DESCRIPTION	QTY
94005518	DRIVER SPINDLE	1

1523BOX3

PART #	DESCRIPTION	QTY
94005519	PASS SPINDLE	1

23003

PART #	DESCRIPTION	QTY
639003	STRUT	2

1523BAG2

<i>For Sway Bar Brackets:</i>	
3/8" NYLOCK NUT	4
3/8" X 1" BOLT	4
3/8" WASHERS	8

<i>For E-Brake Bracket:</i>	
5/16" X 1" BOLT	1
5/16" WASHER	2
5/16" NYLOCK NUT	1

<i>For the Rear Brake Line Bracket:</i>	
5/16" X 3/4" BOLT	1
5/16" NYLOCK NUT	1
5/16" WASHER	2

1263BAG2

<i>For the rear blocks:</i>	
7/16" x 3" x 3" U-BOLTS	4
7/16" NUTS	8
7/16" WASHERS	8



INSTALLATION INSTRUCTIONS

1. Chock the rear wheels and jack up the front of the vehicle.
2. Place jack stands under the frame rails and lower onto jack stands.
3. Remove the wheels/tires.
4. Remove tie-rod end using a 21mm wrench. Using a hammer hit the side of the knuckle to pop tie-rod out. **Photo 1.**
5. Using a 18mm socket remove brake caliper as shown in **Photo 2.** Hang caliper out of way. Do not let caliper hang by brake hose as this will damage hose.

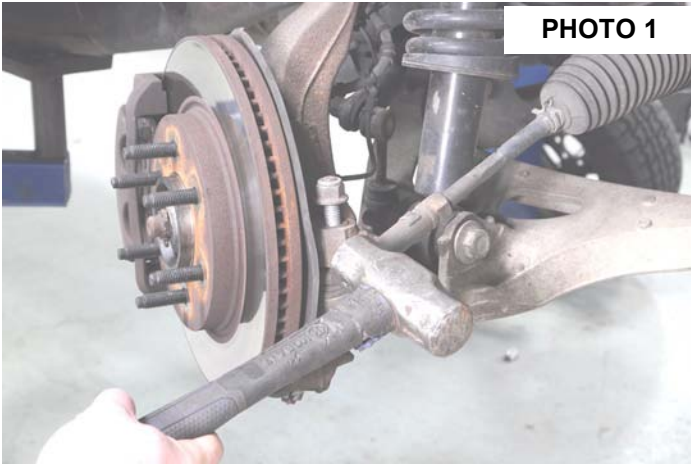

6. Using an 8mm socket remove ABS wire from the knuckle. Retain factory hardware. **See Photo 3.**
7. Remove the cotter pin and nut cover and using a 36mm socket, remove the spindle nut. **See Photo 4.**



8. Remove the brake rotor and bearing assembly from the stub shaft. **See Photo 5.**
9. Using an 8mm socket, remove the brake dust shield. Retain for reuse. **See Photo 6.**



10. Using a 22mm wrench, loosen the upper ball joint nut. **See Photo 7. Do not completely remove the nut.**

11. Strike the knuckle with a hammer to dislodge the ball joint taper. **See Photo 8.**

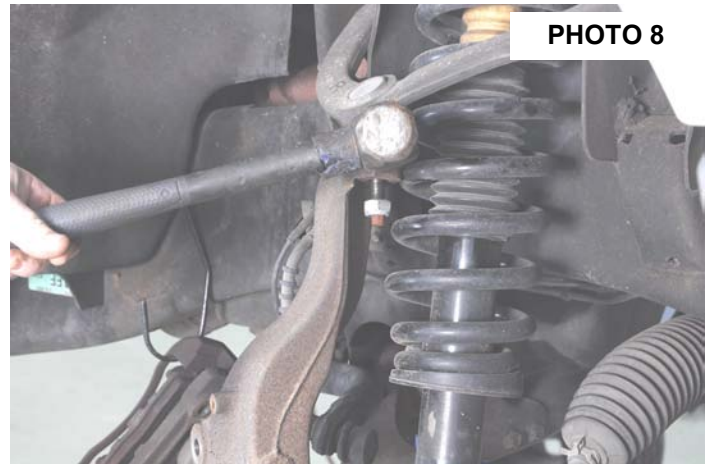
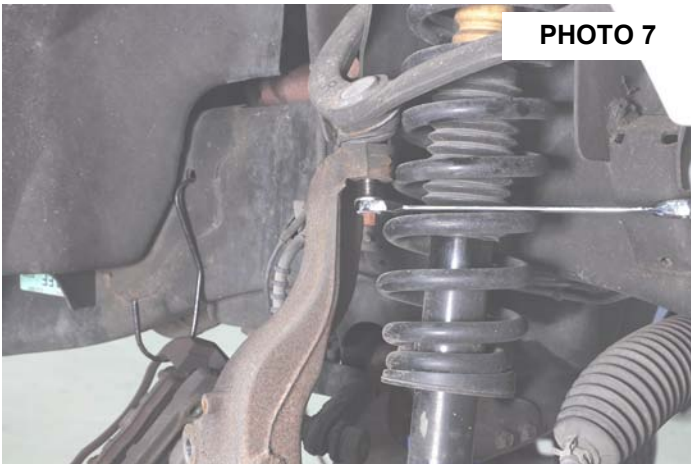

12. Using a 22mm wrench, loosen the lower ball joint nut. **See Photo 9. Do not completely remove the nut.**

13. Strike the knuckle with a hammer to dislodge the ball joint taper. **See Photo 10.**

14. Remove the knuckle and retain the factory hardware.



15. Using a 21mm wrench, remove the sway link from the sway bar. **See Photo 11.**

16. Using a 30mm socket and 27mm wrench, remove the lower strut mounting bolt. Retain hardware for reuse. **See Photo 12.**

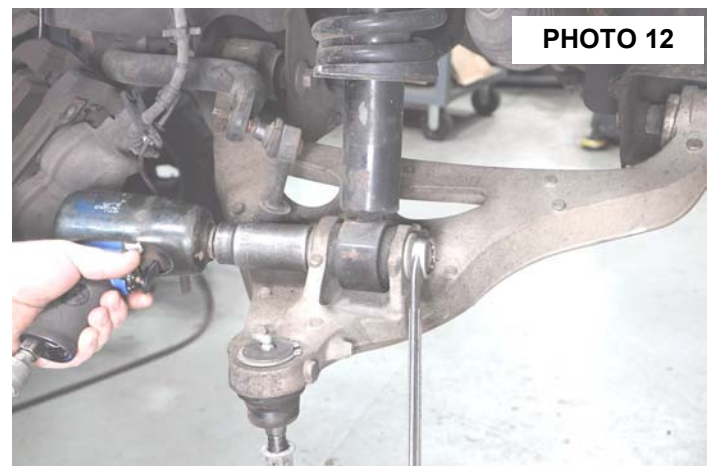
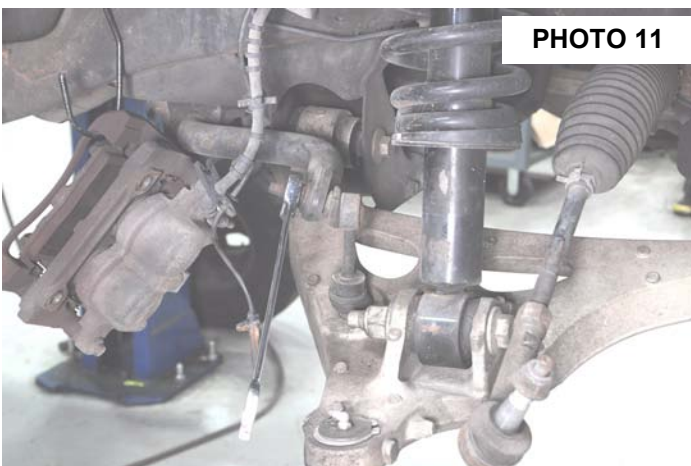

17. Remove the upper strut nuts using a 15mm wrench. Retain hardware for reuse. **See Photo 13.**
18. Remove the strut from the truck.
19. Remove the sway bar using a 15mm socket. Set the sway bar aside for re-installation. **See Photo 14.**

PHOTO 13



PHOTO 14



20. Using a 21mm socket and 27mm wrench, remove the lower control arms. **See Photos 15 & 16.**

PHOTO 15

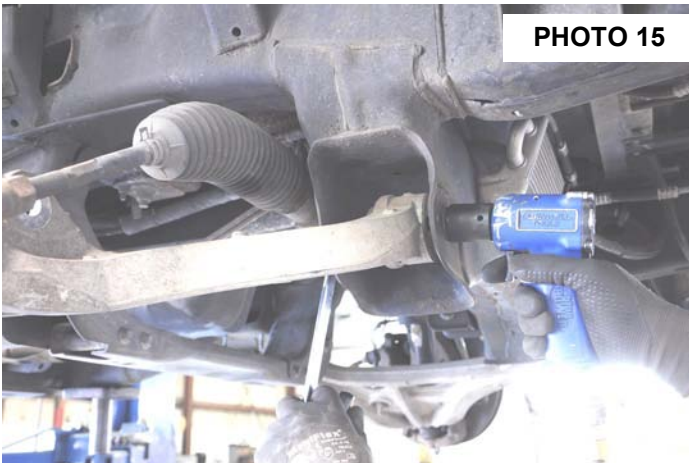

PHOTO 16



21. On the front of the rear control arm pocket, measure 3/4" from the end of the crossmember and mark. **See Photo 17.**
22. Measure up 3/8" from the corner of the control arm pocket and mark. **See Photo 18.**

PHOTO 17



PHOTO 18



23. Draw a line connecting the 2 marks and cut along the line using a reciprocating saw. **See Photo 19.**
24. Repeat steps 21-23 on the opposite side of the truck.
25. Sand the cut area smooth and paint to prevent rust.
26. Install the rear crossmember using the factory hardware. **Do not tighten at this time. See Photo 20.**



PHOTO 19

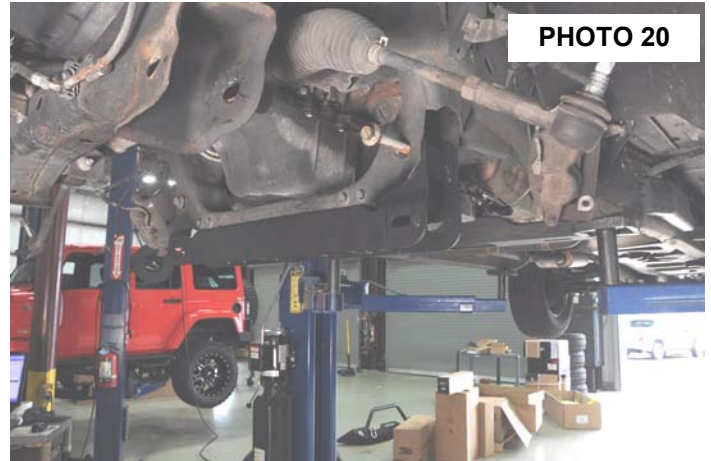

PHOTO 20

27. Install the front crossmember using the factory hardware. **Do not tighten at this time. See Photo 21.**
28. Install the lower control arms using the supplied cam bolts and washers (1500). **Photo 22.**



PHOTO 21



PHOTO 22

29. Strut kits, refer to instructions included with the strut and skip to step 32.
30. Install the studs (10MMSTUDBAG-1) into the strut. Use the supplied 1/2" nut and a 10mm nut to pull the stud into the spacer. **Do not use an impact to install the studs into the strut spacer.**
31. Install the strut spacer assembly onto the strut using the factory hardware. Tighten using a 15mm wrench. **See Photo 23.**
32. Install the strut assembly into the upper strut mount using the supplied hardware (10MMSTUDBAG-1). **Do not tighten at this time. See Photo 24.**

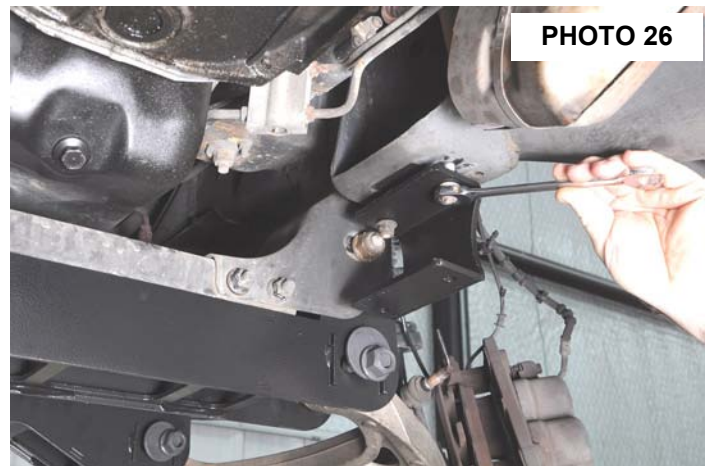
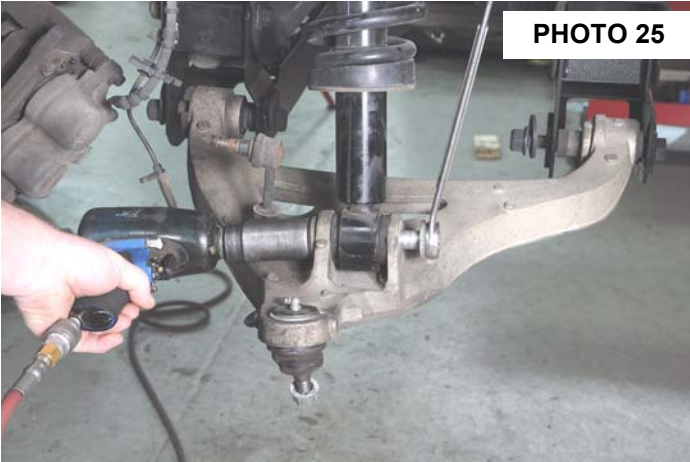

PHOTO 23

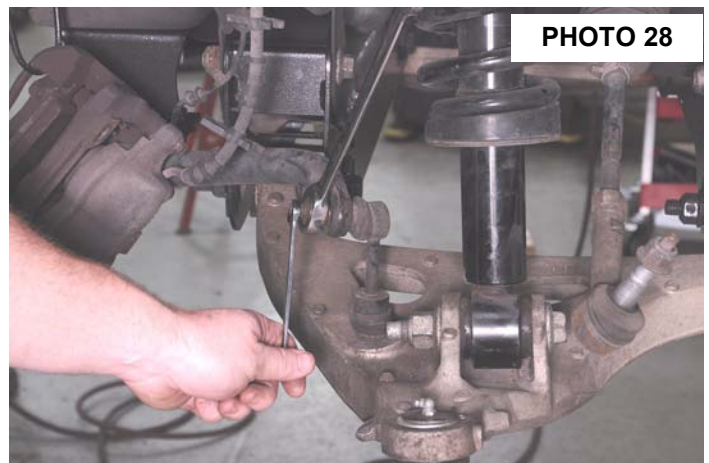

PHOTO 24

33. Install the strut in the mount on the lower control arm using the factory hardware. Torque to factory spec using a 30mm socket and a 27mm wrench. **See Photo 25.**
34. Tighten the upper strut hardware using a 17mm wrench.
35. Install the sway bar drop brackets using the factory hardware. Torque to factory specs using a 15mm socket. **See Photo 26.**



36. Install the sway bar onto the drop brackets using the supplied 3/8" x 1" bolts, washers, and nylock nuts (1523BAG2). Torque to 30ft/lbs using a 9/16" socket and wrench. **See Photo 27.**
37. Attach the sway link to the sway bar using a 10mm and a 21mm wrench. **See Photo 28.**



38. Install the supplied brake lines (89711) from the bracket to the brake caliper.

39. Install the supplied lift spindle using the factory ball joint hardware. **See Photo 29.**

40. Tighten the upper ball joint nut using a 10mm and 22mm wrench. **See Photo 30.**



41. Tighten the lower ball joint nut using a 22mm wrench and install a new cotter pin. **See Photo 31.**

42. Install ABS sensor in the knuckle using the factory hardware and a 10mm socket. **See Photo 32.**

43. Install the factory dust shield using the factory hardware. Tighten using a 8mm socket.



44. **Apply a small amount of grease to the stub shaft** and install the brake rotor and bearing assembly using the factory nut. Tighten using a 36mm socket. **See Photo 33.**

45. Install the nut lock and a new cotter pin. **See Photo 34.**

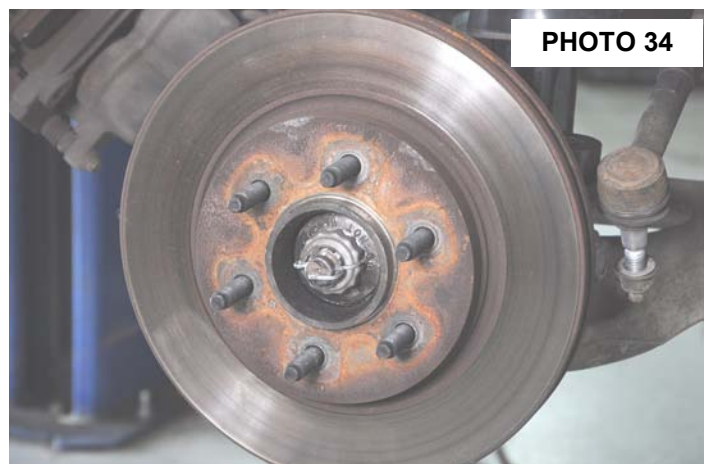

46. Install the brake caliper using the factory hardware. Torque to factory specs using an 18mm socket. **See Photo 35.**
47. Flip the tie-rod end and install into the knuckle using a 21mm wrench to tighten. **See Photo 36.**

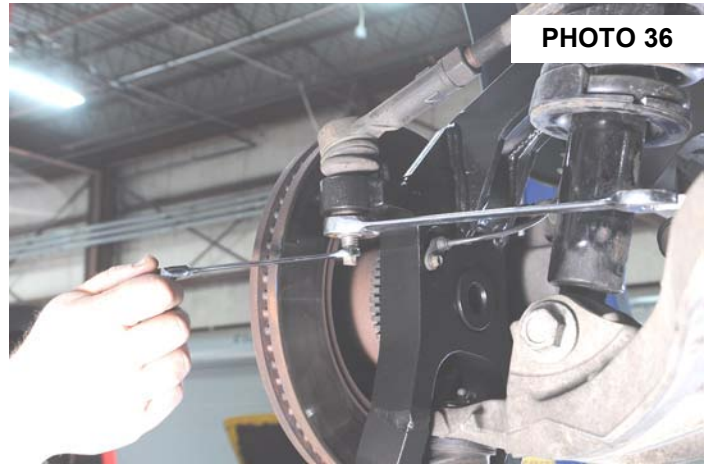
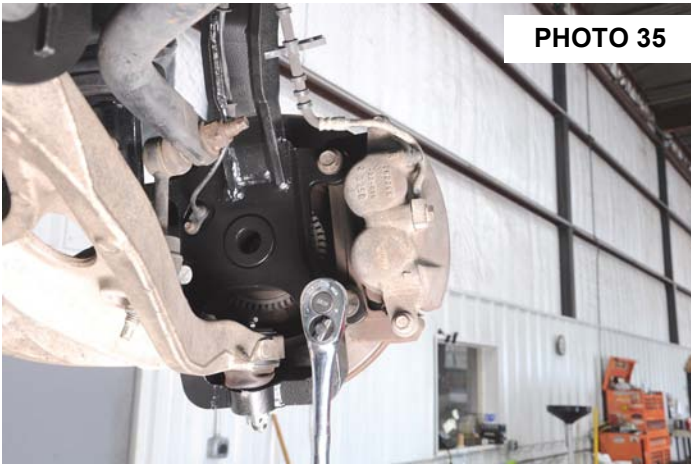

48. Bleed the front brake lines of all air.
49. Install tires and wheels and lower to the ground. Tighten the lower control arm bolts.

REAR INSTALLATION

1. Chock the front tires and jack the rear the rear end up. Put jack stand under the frame rail and lower truck onto jack stands.
2. Remove tires and wheels.
3. Remove rear shocks from the upper and lower mount using 18mm and a 15mm wrench. **See Photo 1 & 2.**

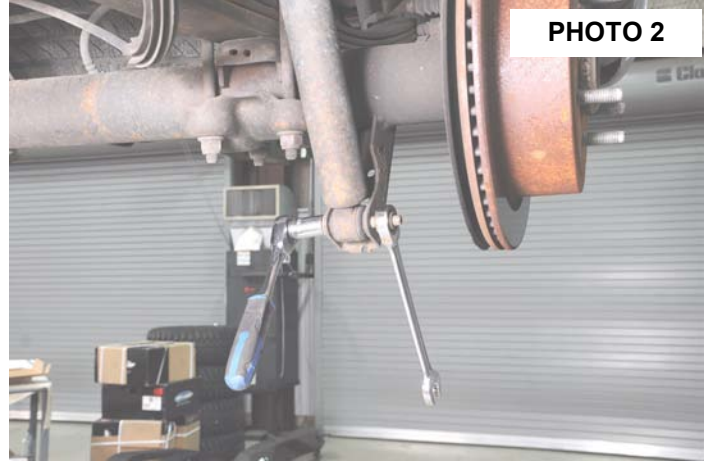

4. Using a 10mm socket, remove the brake line bracket from the frame. Retain hardware for reuse. **See Photo 3.**
5. Using a jack support the rear end on one side and remove the ubolts using a 21mm socket. **See Photo 4.**
6. **6" kit, skip to step 13.**

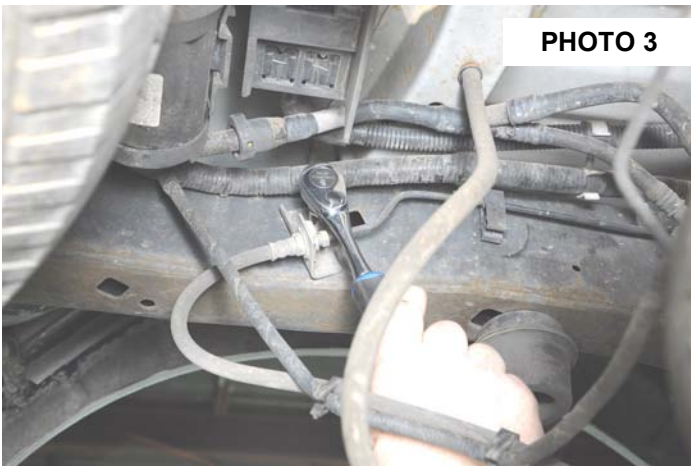

7. Install the supplied block, larger end will go to the rear of the truck. **See Photo 5.**
8. Install the supplied ubolts and hardware. Torque to 90ft/lbs using a 13/16" socket in an X pattern. **See Photo 6.**

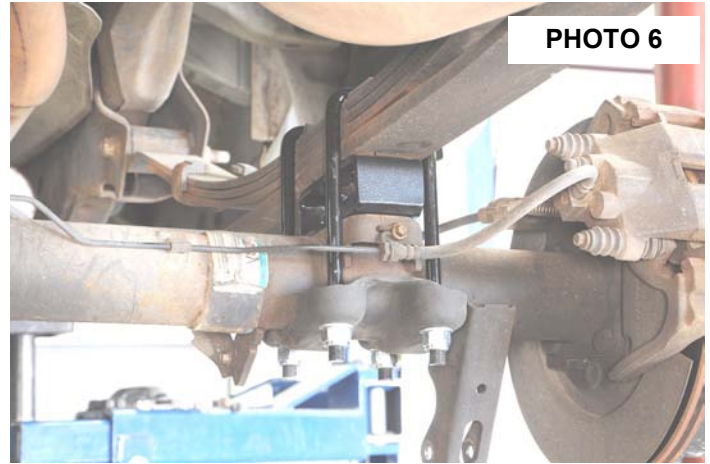
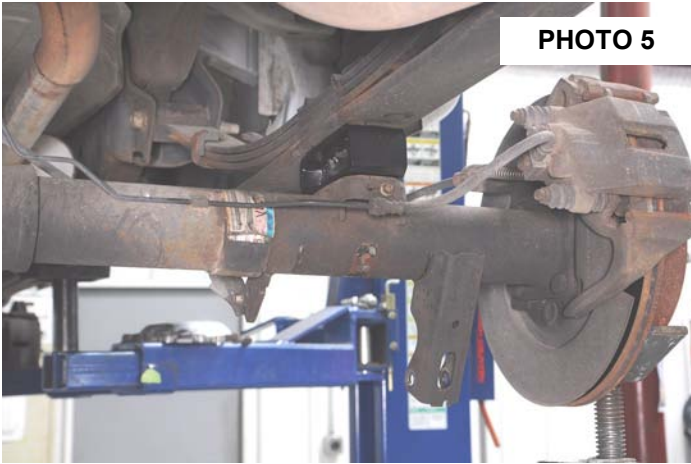

9. Install the supplied shocks using the factory hardware. Torque to factory specs using 15mm wrench and 18mm socket. **See Photos 7 & 8.**
10. Re-install the brake line bracket on the frame using the factory hardware and a 10mm socket.

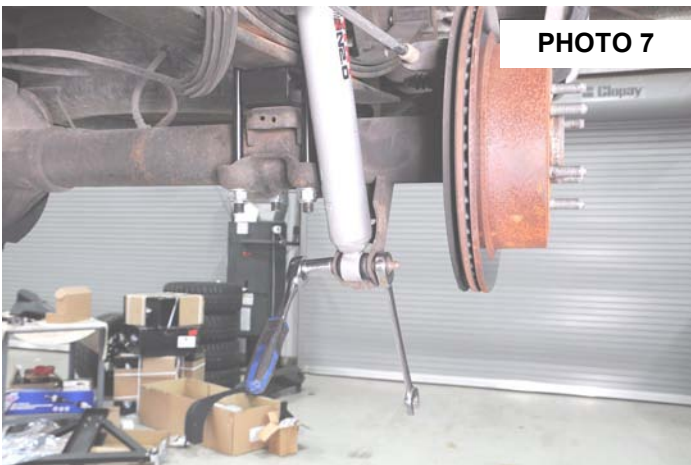

11. Install the wheels and tires.
12. Lower the vehicle to the ground.
13. Using a 10mm wrench, 24mm wrench, and 27mm socket, remove the emergency brake line bracket. Retain hardware for reuse. **See Photo 9.**
14. Install the supplied emergency brake line drop bracket using the factory hardware. **See Photo 10.**



15. Disconnect and remove the emergency brake cable from the factory bracket. **See Photo 11.**

16. Install the emergency brake cable into the new bracket. **See Photo 12.**



PHOTO 11



PHOTO 12

17. Re-connect the emergency brake cable. **See Photo 13.**

18. Tighten the factory hardware using a 10mm socket, 24mm wrench, and 27mm socket. Torque to factory specs. **See Photo 14.**



PHOTO 13



PHOTO 14

19. Remove the factory ubolts using a 21mm socket. **See Photo 15.**

20. Install the supplied block, larger end to the rear of the truck, using the supplied 9/16" ubolts and 7/16" anti-wrap ubolts. Torque the 9/16" ubolts to 90 ft/lbs using a 13/16" socket and the 7/16" ubolts to 45ft/lbs using a 5/8" socket. **See Photo 16.**



PHOTO 15

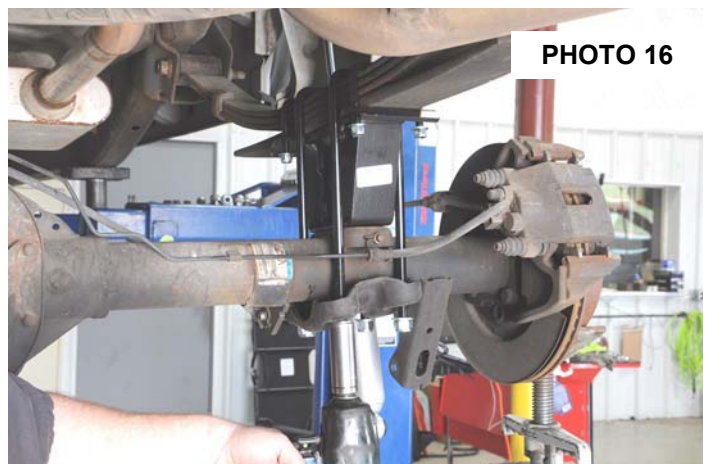

PHOTO 16

21. Install the supplied shocks using the factory hardware. Torque to factory specs using 15mm wrench and 18mm socket. **See Photo 17.**
22. Install the new brake line bracket on the drivers side frame rail in the stock mount with factory hardware and install the stock brake line bracket to the new bracket with the supplied 5/16" x 3/4" bolt/washers & nut. Remove the stock diff hose from the stock mount and install into the new bracket. **See Photo 18.**



14. Install the wheels and tires.
15. Jack up the vehicle and remove the jack stands. Lower the vehicle to the ground.

POST INSTALLATION INSTRUCTIONS

1. Check all fasteners for proper torque. Check to ensure there is adequate clearance between all rotating, mobile, fixed and heated members. Check steering gear for interference and proper working order. Test brake system
2. Perform steering sweep. Check to ensure brake hoses have sufficient slack and will not contact rotating, mobile, or fixed members, adjust lines/brackets to eliminate interference and maintain proper working order. Failure to perform inspections may result in component failure
3. Readjust headlights to factory settings
4. Have vehicle aligned by a certified alignment professional.
5. Re-torque all nuts, bolts, and especially u-bolts after the first 100 miles, again after another 100 miles and then check periodically thereafter
6. All components must be retightened after 500 miles, and every three thousand miles after installation.
7. Rough Country recommends not operating the vehicle in 4 wheel drive above 40 mph. Doing so may result in a low frequency front driveshaft vibration. If vibration does occur please refer to included instructions in this sheet to re-lock the driveshaft.

THANK YOU FOR CHOOSING ROUGH COUNTRY FOR YOUR SUSPENSION NEEDS

By purchasing any item sold by Rough Country, LLC, the buyer expressly warrants that he/she is in compliance with all applicable , State, and Local laws and regulations regarding the purchase, ownership, and use of the item. It shall be the buyers responsibility to comply with all Federal, State and Local laws governing the sales of any items listed, illustrated or sold. The buyer expressly agrees to indemnify and hold harmless Rough Country, LLC for all claims resulting directly or indirectly from the purchase, ownership, or use of the items.

